

RPower OGiV121340LP (12V 134Ah AGM Battery)

Floating Life at 20°C designed for up to 12 years

EAN: 4260349823456

Dimensions

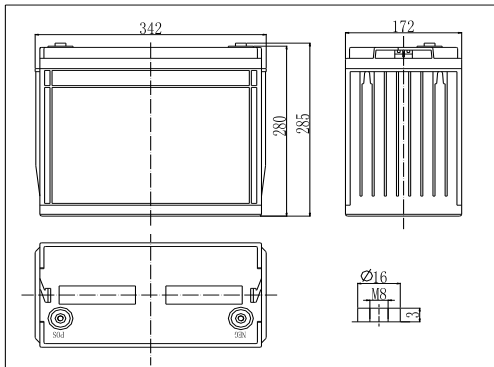

Specifications

Nominal Voltage		12V
Capacity (10hr@25°C@1.80V/C)		134Ah
Dimensions (±2mm)	Length	341mm (13.4inch)
	Width	173mm (6.81inch)
	Height	283mm (11.1inch)
	Total Height	287mm (11.3inch)
Approx. Weight		39.50kg (87.08lbs)
Maximum charging current		40A
Maximum discharge current		950A (5sec.)
Internal resistance		Approx. 3.8mΩ
Capacity affected by temperature (20hr)	40°C	103%
	25°C	100%
	0°C	86%
	-15°C	65%
Self-discharge (25°C)	3 month	Remaining Capacity: 91%
	6 month	Remaining Capacity: 82%
	12 month	Remaining Capacity: 65%
Nominal operating temperature		25°C ±3°C (77°F±5°F)
Operating temperature range		-20°C~55°C (-4°F~131°F)
Float charging voltage (25°C)		13.65 to 13.80V
Cyclic charging voltage (25°C)		14.40 to 15.00V
Terminal material		Copper

The Relationship for Charging Voltage and Temperature

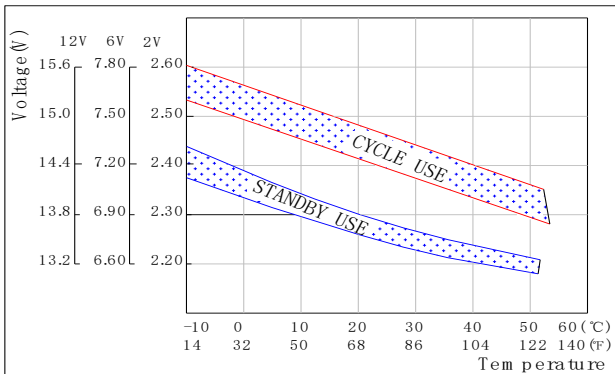

Charging Characteristics (25°C)

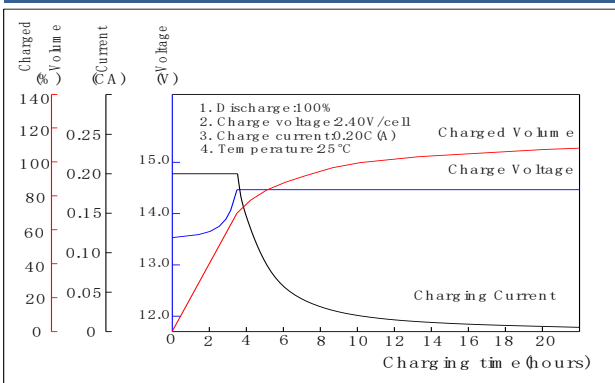

Discharge Characteristics (25°C)

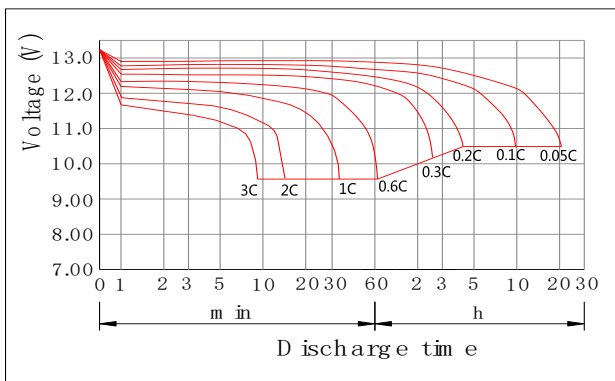

Constant Current Discharge Characteristics (Ampere / Battery, 25°C)

FV / TIME	5min	10min	15min	20min	30min	45min	1h	2h	3h	4h	5h	6h	8h	10h	20h
10.98V	--	227,95	191,09	161,02	129,98	93,80	75,66	44,52	34,14	26,77	22,31	19,21	15,33	13,00	6,83
10.80V	--	235,00	197,00	166,00	134,00	96,70	78,00	45,90	35,20	27,60	23,00	19,80	15,80	13,40	7,04
10.50V	--	257,00	214,00	177,00	139,00	99,80	80,20	47,10	36,10	28,30	23,60	20,20	16,00	13,50	7,09
10.20V	--	280,00	231,00	187,00	142,00	102,00	82,10	48,10	36,80	29,00	24,30	20,70	16,20	13,50	7,10
9.90V	--	292,00	237,00	191,00	145,00	105,00	84,30	49,10	37,40	29,70	25,00	21,20	16,40	13,60	7,14
9.60V	--	314,00	248,00	197,00	147,00	107,00	86,50	50,30	38,20	30,30	25,60	21,60	16,60	13,60	7,16

Constant Power Discharge Characteristics (Watt / Battery, 25°C)

FV / TIME	5min	10min	15min	20min	30min	45min	1h	2h	3h	4h	5h	6h	8h	10h	20h
10.98V	--	2607,36	2275,62	1856,58	1437,54	1099,98	873,00	516,23	396,92	309,04	256,08	218,25	171,11	142,59	77,03
10.80V	--	2688,00	2346,00	1914,00	1482,00	1134,00	900,00	532,20	409,20	318,60	264,00	225,00	176,40	147,00	79,41
10.50V	--	2898,00	2484,00	2004,00	1524,00	1152,00	912,00	537,00	411,60	322,20	268,80	229,80	180,60	151,20	80,40
10.20V	--	3072,00	2562,00	2058,00	1548,00	1170,00	924,00	543,60	417,00	328,80	275,40	235,20	184,80	154,20	81,00
9.90V	--	3174,00	2598,00	2082,00	1566,00	1200,00	948,00	553,20	421,80	334,20	282,00	240,60	189,00	157,80	82,20
9.60V	--	3396,00	2844,00	2286,00	1722,00	1236,00	978,00	567,60	430,80	339,60	284,40	243,60	192,00	161,40	84,00